



TECE drainline shower channel, straight, with wall upstand and Seal System sealing tape

Article number: 600901

Nominal length: 900 mm

Total length L: 911 mm

Visible dim. after installation: 851 mm

Width in unfinished state: 124 mm

Visible width

after installation: 69 mm

DU 1: 1 pc.

DU 2: 32 pc.

Description:

Straight channel body with wall upstand for installation in the screed against the wall, with flange and Seal System sealing tape, for creating an independently tested connection of the TECE drainline shower channel to the composite seal.

Consisting of:

- Channel body with flange made of polished stainless steel, material 1.4301 (304)
- Seal System sealing tape with matting for installation by the customer in the liquid or strip composite seal
- Connecting clips for anchoring in the screed and fitting of optional assembly feet
- Central connection piece for drain
- Internal incline for improved water drainage and self-cleaning effect
- Seal

Sales data:

Product name: TECE drainline channel, straight with wall upstand 900 mm with Seal System sealing tape

Commodity group: 600

Product group: 3006000010

Dimensional drawings:

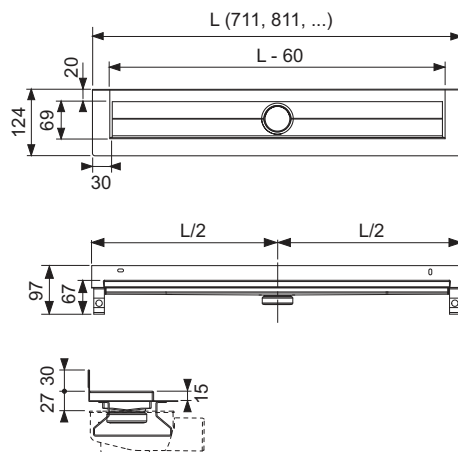

Spare parts:

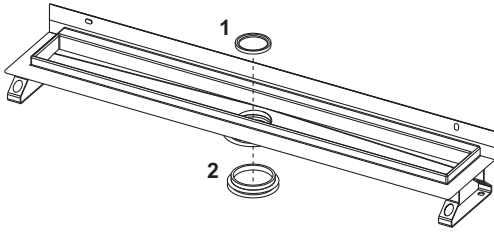

- | | | |
|---|--------|---|
| 1 | 668012 | Immersion pipe seal |
| 2 | 668013 | Seal between channel and outlet, until 2015 |