



TECEdrainline shower channel for natural stone, straight, with Seal System sealing set and stainless steel support as a set

Article number: 650900

Nominal length: 900 mm

Total length L: 935 mm

Support sheet length

L - 89: 846 mm

Covering cut-out length

L - 87: 848 mm

DU 1: 1 pc.

DU 2: 40 pc.

Description:

Straight channel body and support sheet for TECEdrainline shower channel, for installation in the screed and laying by the customer of large tiles/natural stone slabs, with flange and Seal System sealing tape, for creating an independently tested connection of the TECEdrainline shower channel to the composite seal.

Consisting of:

- Channel body with flange made of polished stainless steel, material 1.4301 (304)
- Seal System sealing tape with matting for installation by the customer in the liquid or strip composite seal
- Connecting clips for anchoring in the screed and fitting of optional assembly feet
- Central connection piece for drain
- Internal incline for improved water drainage and self-cleaning effect
- Support sheet made of stainless steel – material 1.4301 (304) – for fitting in the channel body
- Seals

Sales data:

Product name: TECEdrainline shower channel straight for natural stone 900 mm with Seal System sealing tape

Commodity group: 600

Product group: 3006000030

Dimensional drawings:

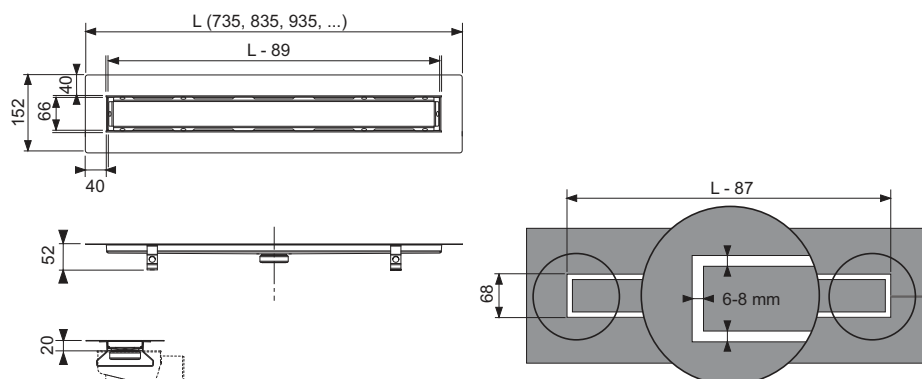

Spare parts:

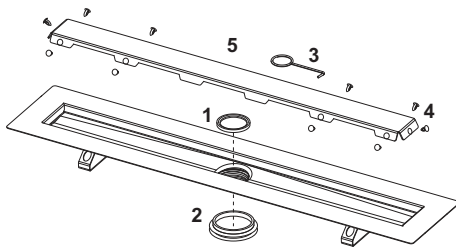

- | | | |
|---|--------|---|
| 1 | 668012 | Immersion pipe seal |
| 2 | 668013 | Seal between channel and outlet, until 2015 |
| 3 | 668014 | Lift tool |
| 4 | 668016 | Spacer clip |
| 5 | 668028 | Support sheet shower channel natural stone 900 mm |