



TECEdrainprofile shower profile with coloured PVD surface

Article number: 671213

Length: 1200 mm
 Width: 55 mm
 Colour: Polished Red Gold
 Matching to: hansgrohe / AXOR
 DU 1: 1 pc.

Description:

Shower profile for shower drainage, for installation in tile adhesive above the screed and seal.

The PVD finishes are colour matched to the TECEsquare II metal toilet flush plates and the latest offers from leading manufacturers including those from the hansgrohe / AXOR collections.

Consisting of:

- Shower profile that can be cut to length with internal incline for improved water drainage and self-cleaning effect
- Shower profile can be shortened to ≥ 500 mm
- Profile lid with "Push Function" for removal by hand, durable to load class K3 - maximum test load 300 kg
- Shower profile and profile lid, made of stainless steel material 1.4301 (304) with coloured PVD coating
- Connection pieces for connection with a TECEdrainprofile drain
- Grip elements for easy installation and solid connection with the tile adhesive
- For floors from 8-25 mm (incl. adhesive bed)
- For flush to the wall installation for wall coverings from 10 mm (incl. adhesive bed)
- For installation at the wall (flush to the wall) or at any specific distance from the wall

Sales data:

Product name: TECEdrainprofile shower profile, 1200 mm, stainless steel, "Polished Red Gold"
 Commodity group: 608
 Product group: 3006080011

Dimensional drawings:

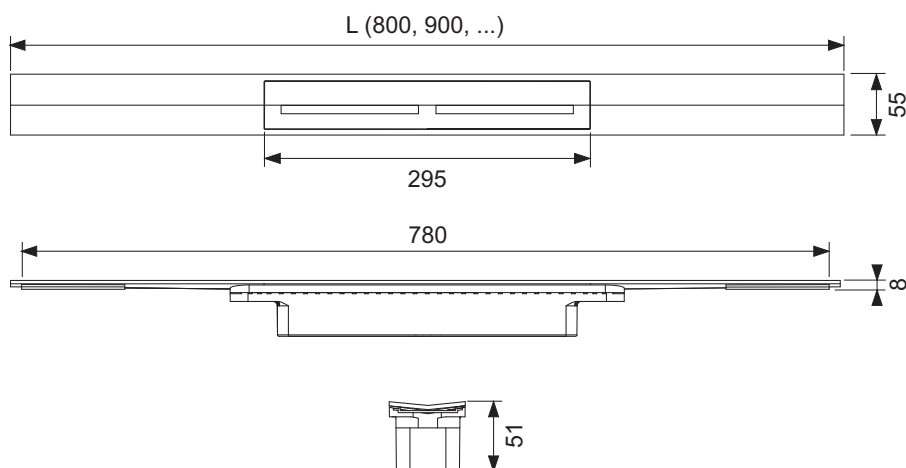

Spare parts:

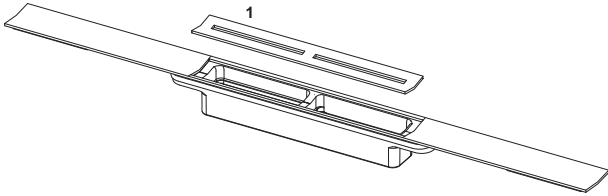

- 1 675015 Profile lid stainless steel, "Polished Red Gold"