

Una versatile collezione di rubinetteria tre fori.

A versatile collection of three-hole taps.

Une collection versatile de robinet 3 trous.



stella
1882

www.rubinetteriestella.it

Collections by Meneghella Paolelli Associati

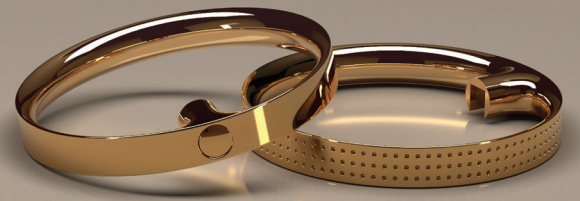

Il Coassiale da Indossare.

The Coaxial to wear.

Le Coaxial a endosser.

stella
1882



Macarons è una versatile collezione di rubinetteria tre fori capace di interpretare al meglio le necessità dei singoli utenti e dei mercati di riferimento. Abbiamo scomposto la maniglia in 3 differenti elementi sovrapponibili, appunto come i macarons, affinché i singoli layers potessero comporsi tra di loro in un "mix and match" di materiali e finiture.

Macarons is a versatile collection of three-hole taps able to best interpret the needs of individual users and the reference markets. We have broken down the handle into 3 different overlapping elements, just like the macarons, so that the individual layers could be composed together in a "mix and match" of materials and finishes.

Macarons est une collection polyvalente de robinets à trois trous capables d'interpréter au mieux les besoins des utilisateurs et des marchés de référence. Nous avons divisé la poignée en 3 éléments différents qui se chevauchent, tout comme les macarons, afin que les couches individuelles puissent se composer dans un "mix and match" de matériaux et de finitions.

Collections by Meneghella Paolelli Associati



Charm è la nostra interpretazione del rubinetto a miscelazione assiale. La leva concentrica fluttua nel vuoto acquisendo così forza ed esclusività, un dettaglio prezioso che caratterizza la collezione.

Charm is our interpretation of the axial mixing tap. The concentric lever floats in the void thus acquiring strength and exclusivity, a precious detail that characterizes the collection.

Charm est notre interprétation du mitigeur axial. Le levier concentrique représente une force dans le vide acquérant ainsi une certaine exclusivité, un détail précieux qui caractérise cette collection.



Disponibile in diverse finiture materiche /
Available in different material finishes /
Disponibile en différentes finitions de matériaux

COVER TOP / SUGGESTIONS

-  .CC
marmo calacatta /
marble calacatta /
marbre calacatta
-  .EM
marmo emperador /
marble emperador /
marbre empereur
-  .LG
graniglia bianco /
grit white /
grain blanc
-  .DG
graniglia grigio /
grit grey /
grain gris
-  .LW
legno noce /
wood walnut /
bois de noyer
-  .DW
legno teak /
wood teak /
bois de teck

Disponibile in finitura lucida con e senza decoro /
Available in glossy finish with and without texture /
Disponibile en finition brillante avec et sans décoration

ANELLO RING / SUGGESTIONS

-  .PV18
nero /
black /
noir
-  .AU00
oro /
gold /
or
-  .PV02
nichel /
nickel /
nickel
-  .PV16
rame /
copper /
cuivre

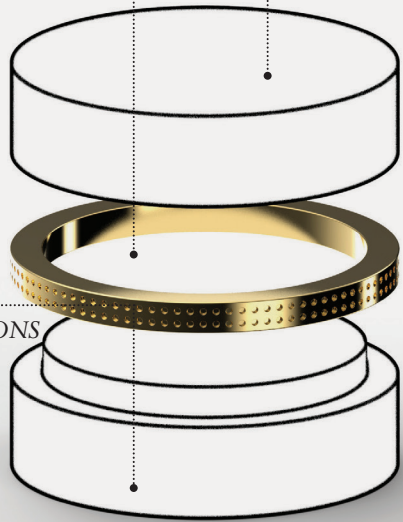

Disponibile in finitura opaca /
Available in matt finish /
Disponibile en finition mat

BASE HANDLE / SUGGESTIONS

-  .BI00
bianco /
white /
blanc
-  .PV17
nero /
black /
noir
-  .MOKA
moka /
moka /
moka

TECHNICAL & MATERIAL / DETAILS



MATERIAL MIX / SAMPLES

Collections by Meneghello Paoelli Associati

Esempi di possibili configurazioni di gruppi
miscelatore e lavabi incasso tre fori, a fianco
una selezione di componenti relativi a
maniglie, bocche, basi...





Examples of possible concealed mixers and
three-holes washbasins configurations, as
well as a selection of components related to
handles, spouts, bases and rosettes...

Exemples de configurations possibles des
mitigeurs et lavabos encastrés trois trous,
ainsi qu'une sélection de composants liés aux
poignées, becs, embases et rosaces...



Disponibile in finitura lucida con e senza decoro /
Available in glossy finish with and without texture /
Disponibile en finition brillante avec et sans décoration

ANELLO RING / SUGGESTIONS

-  .PV18
nero /
black /
noir
-  .AU00
oro /
gold /
or
-  .PV02
nichel /
nickel /
nickel
-  .PV16
rame /
copper /
cuivre

Cartuccia coassiale con apertura ambidestra /
Coaxial cartridge with ambidextrous opening /
Cartouche coaxiale à ouverture ambidextre

TECHNICAL HEART / INSIDE

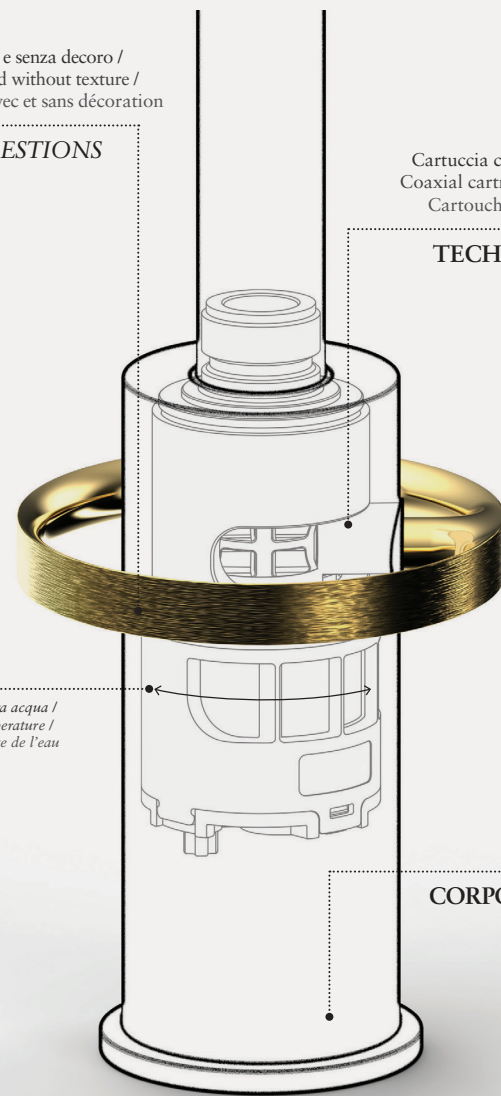

Temperatura acqua /
Water temperature /
Température de l'eau

Portata acqua /
Water flow /
Débit d'eau



Disponibile in finitura opaca /
Available in matt finish /
Disponibile en finition mat

CORPO BODY / SUGGESTIONS

-  .PV17
nero /
black /
noir
-  .AU01
oro /
gold /
or
-  .PV14
nichel /
nickel /
nickel
-  .PV11
rame /
copper /
cuivre

TECHNICAL & MATERIAL / DETAILS

MATERIAL MIX / SAMPLES

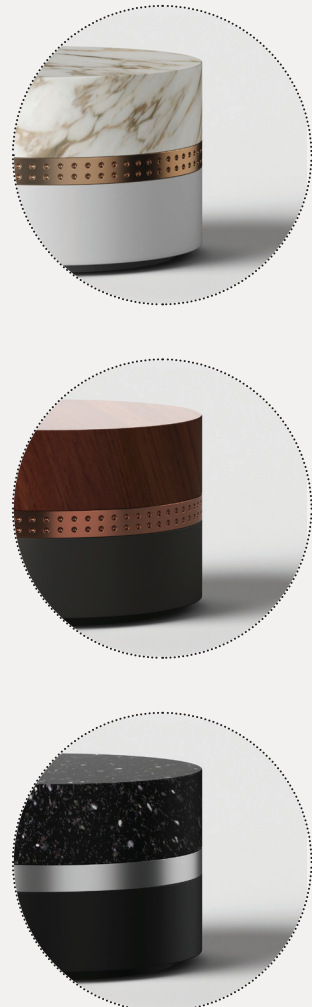

Collections by Meneghello Paoelli Associati

Esempi di possibili configurazioni di gruppi
miscelatore e lavabi incasso tre fori, a fianco
una selezione di componenti relativi a
maniglie, bocche, basi...

Examples of possible concealed mixers and
three-holes washbasins configurations, as
well as a selection of components related to
handles, spouts, bases and rosettes...

Exemples de configurations possibles des
mitigeurs et lavabos encastrés trois trous,
ainsi qu'une sélection de composants liés aux
poignées, becs, embases et rosaces...